

# Building Units for Masonry Stoves

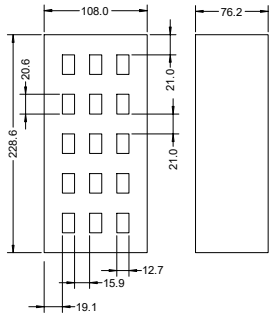

"Select" Brick With Holes

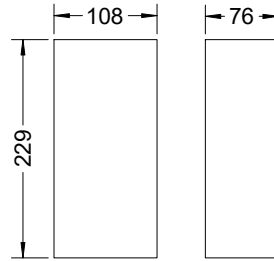

High Temp Solid Brick

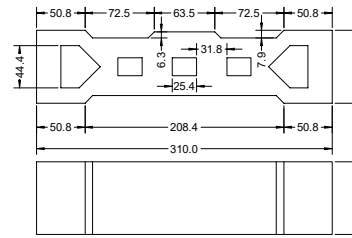

Small Stove Grate Brick  
50 L stoves only

The chimney connector may fit inside or outside of the metal chimney.

Outside is preferred as it conducts condensation into the stove.

Cut to length

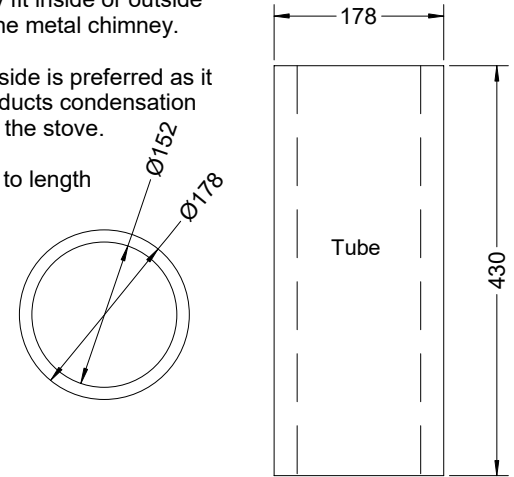

Clay Chimney Connector

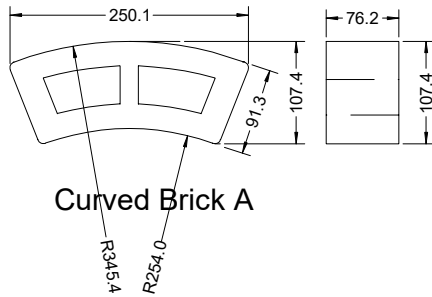

Curved Brick A

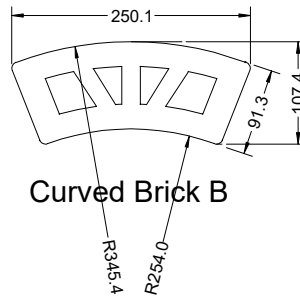

Curved Brick B

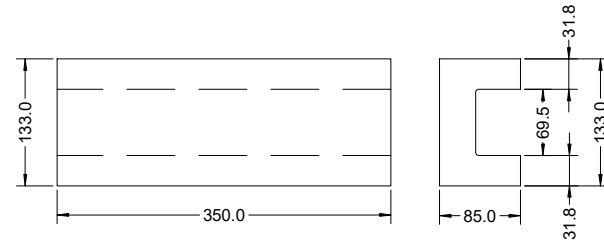

Clay Cable Cover

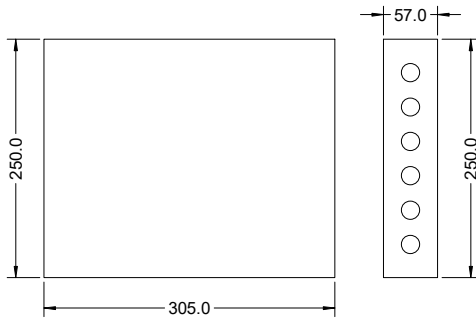

Perforated Clay Tile (optional)  
Not normally used

<h2>Construction Units for 300 Litre Stoves</h2>		2024 MEMD STOVES
		Key Features: Solid high temperature bricks Perforated select bricks Curved select bricks Cable cover (channel) units Optional plates
		Material: Brick and High temperature brick
		Quantity: Various
		Scale: Not to scale
Version: 1.32	Date: 2024-12-02	Initials: CPP
Drawing No. 06 MEMD Stoves - Building Units		Drawn By: C Pemberton-Pigott
		Part: Building units